

OCEAN KING 3 Plus

Blackbeard's Fury

Operator Manual

Revision: 18-08-17 MD900US

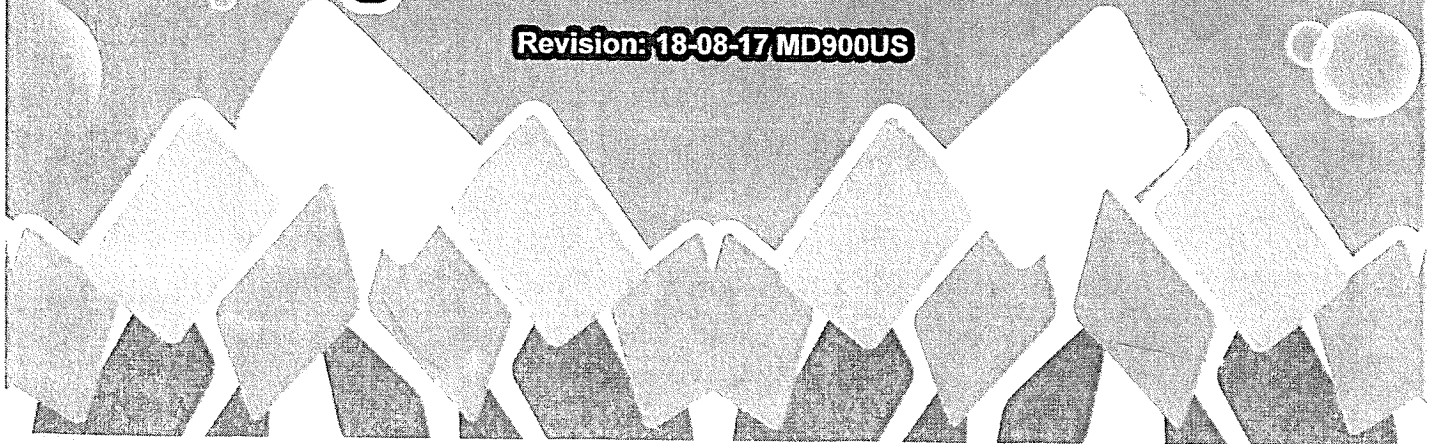



Safety Notice

► General

- DO NOT disassemble, change and modify the machine without authorization.
- Make sure to operate the machine as instructed by this manual. Inappropriate handling of the machine will cause damage to the machine and injury threat to players and spectators.
- Please check and maintain the machine regularly.
- Make sure that the warning labels are clean to be clearly read. If the label is too dirty to be clearly read, replace a new label immediately.



► Installation Sites

- This machine is designed for indoor use. DO NOT place it outdoors. Make sure the machine is not installed in the following venues:
 - Place of direct sunlight exposure, water contact, high humidity and high temperature.
 - Places where there is flammable and volatile chemicals and hazardous substances.
 - Places where the ground is sloping, uneven or there is strong vibration.
 - Places close to emergency exits and fire extinguishers.
- DO NOT obstruct the ventilation holes to avoid damage to the machine.
- Make sure the machine is separate from the wall, other machines and passages by at least 30 cm.



► Power

- Before connecting the machine to the mains supply, verify that the voltage is correct to avoid fires or electric shock.
- When connecting the machine to the mains supply, verify the mains outlet is a grounded outlet.
- To avoid electric shock and short circuit, DO NOT run the power cord or ground wire across passages.
- To avoid fires, DO NOT place any flammable objects close to the power cord.
- In the event of frayed power cord, please contact your dealer for replacement.
- To avoid electric shock or short circuit:
 - Make sure to turn the power OFF before attempting maintenance or repair.
 - DO NOT touch the plug with damp hands.
 - Do not insert/unplug the power plug all of a sudden.
 - When plugging/unplugging the power cord, make sure to hold plug. DO NOT pull on the power cord.



! WARNING **Transportation**

- During transportation, ensure that the castors are fasten.
- The machine contains a LCD monitor which is fragile; avoid strong vibration or rough handling during transportation.

! CAUTION **Moving**

- Before moving the machine, make sure to unplug it from the machine.
- When moving the machine, pay attention to obstructions and uneven surface to avoid accidents or damage to the machine.
- Make to move the machine with at least two personnel to avoid accident and injury.

! CAUTION **During Operation**

- To avoid injury and accidents to players during operation, those falling under the following categories are not allowed to play the game:
 - People with high blood pressure or cardiovascular diseases
 - People who are injured or less mobile
 - Drunk people
- Instruct the players to read the warning labels and follow the instructions to prevent electric shock or short circuit.



Table of Contents

• Safety Notice	01
• ① Game Introduction	04
Operation	04
How to play	05
Introductions of fishes	06
Mini game instructions	07
• ② Using the System Utility	17
Record	18
Test	19
System Setting	20
System Adjustment	21
Coder System	23
• ③ Manual of Coder	24
• ④ Installing instructions for IO board	26
• ⑤ Troubleshooting	36
• ⑥ Notes	37



1. Game Introduction

• Operation

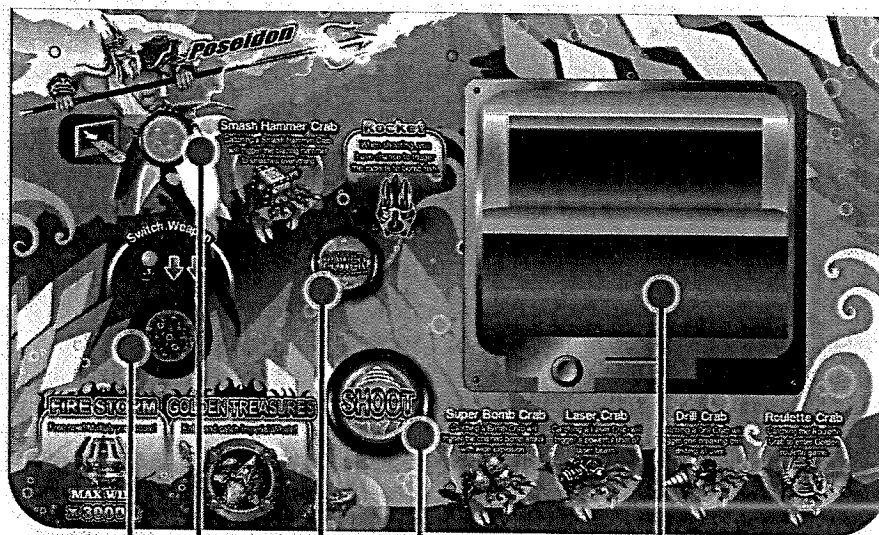

Joystick Payout Button Shoot Button Coin Acceptor

Coin Acceptor: to increase players' Credit.

Joystick: Change the direction of gun tube to aim your target. Press joystick downward twice and switch weapon.

Shoot Button: Aim your target and press this button to shoot bullets. Keep hitting the SHOOT button and accelerate the shooting speed.

Power Button: Press this button to switch bet.

Payout Button: Press this button to get coins out by accord to player's credits.



• How to Play

1.

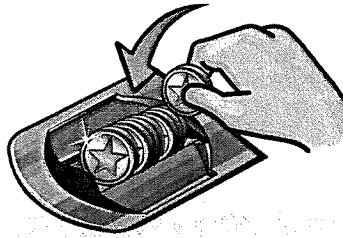

▶ Insert coins to increase players' Credit.

2.



▶ Press the POWER button and switch bet.

3.

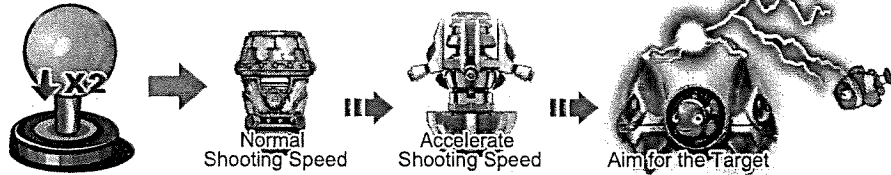

▶ Press joystick downward twice and switch weapon.

4.



▶ Control the joystick to change the direction of the gun tube. When you aim at your target, press the SHOOT button to shoot bullets.

▶ Keep hitting the SHOOT button and accelerate the shooting speed.

▶ When shooting, you have chance to trigger the rockets to bomb fish.

5.

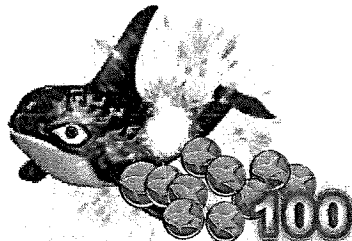

▶ When you hit a fish, it is successfully caught and scores are rewarded.



• Introductions of fishes

Go to SYSTEM > SYSTEM ADJUSTMENT > ODDS LEVEL. The ODDS LEVEL parameter may be set as HIGH or LOW to adjust the odds.

▶ ODDS LEVEL – LOW

Pictures of fishes										
Piont	2	3	4	5	6	7	8	9	10	12

Pictures of fishes										
Piont	15	18	20	10~30	SEE P.07	SEE P.08	SEE P.09	SEE P.10	SEE P.11	20~60

Pictures of fishes										
Piont	30~100	100	100~250 or POWERUP				100~500 or POWERUP			SEE P.16
POWERUP : Power up feature may have a chance to trigger full Awaken Attack and win multiplier reward.										

▶ ODDS LEVEL – HIGH

Pictures of fishes										
Piont	2	3	4	5	6	7	8	9	10	12

Pictures of fishes										
Piont	15	18	20	20~60	SEE P.07	SEE P.08	SEE P.09	SEE P.10	SEE P.11	30~100

Pictures of fishes										
Piont	60~200	350	100~800 or POWERUP				100~1000 or POWERUP			SEE P.16
POWERUP : Power up feature may have a chance to trigger full Awaken Attack and win multiplier reward.										



• Mini game instructions

1.  Super Bomb Crab

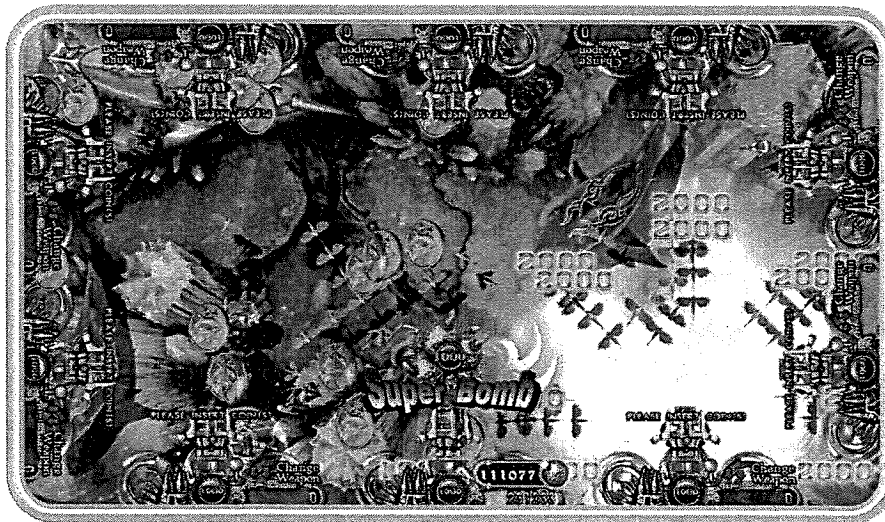
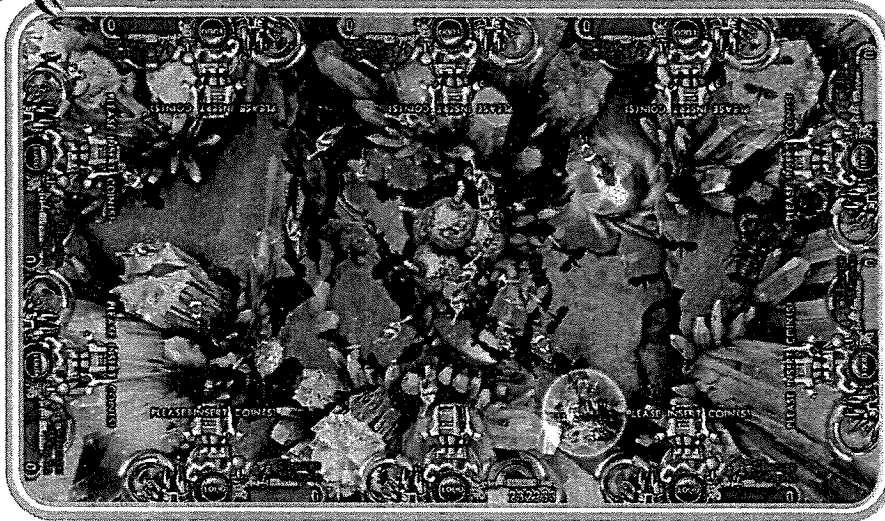

▶ Catching a Bomb Crab will trigger the chained bomb attack in a wide explosion and may have a chance to help catch the fish within.



2. Laser Crab



▶ You will get one shot for Laser Beam in a limited time.

3. Drill Crab

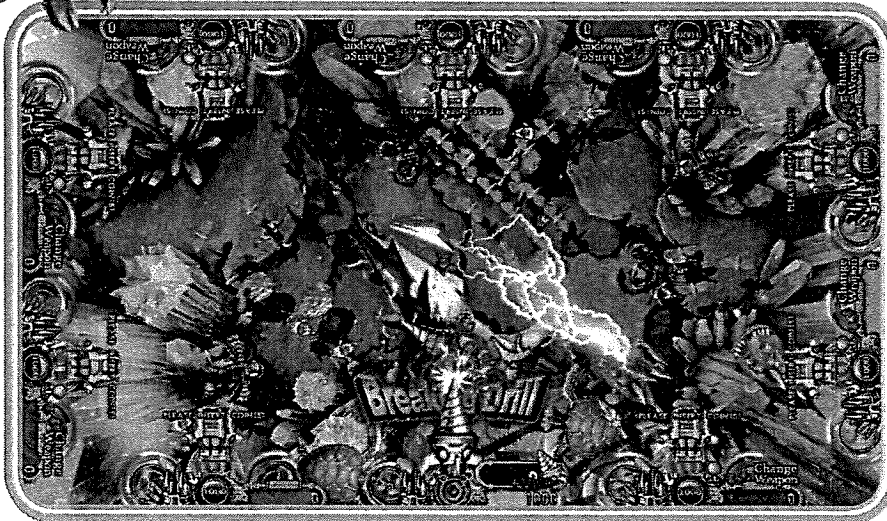

► When a Drill Crab is caught, it fires drills penetrating the area and may have a chance to catch the fish.

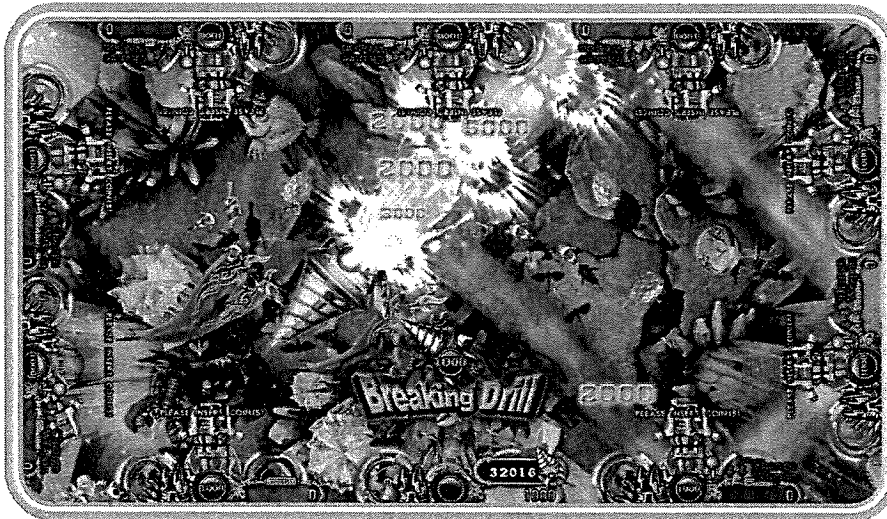

► The drill self-explodes after a while, and may have a chance to catch the fish within the range.



4. Roulette Crab

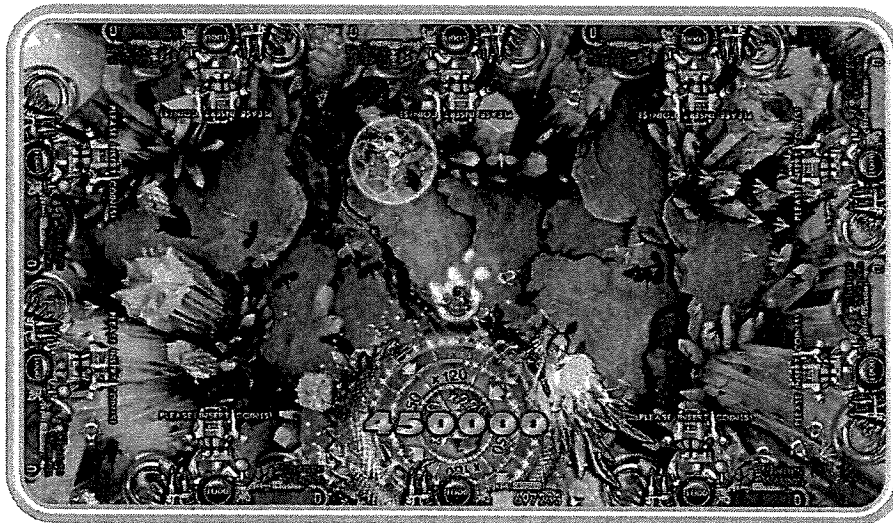

- ▶ You may enter Golden Roulette bonus game.
- ▶ Press shoot button to stop the roulette, the inner roulette the higher score.



5.  **Smash Hammer Crab**

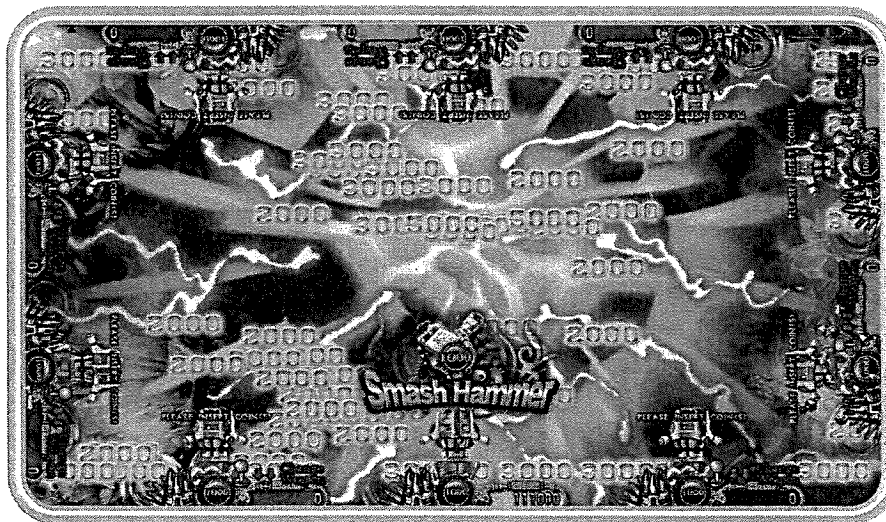
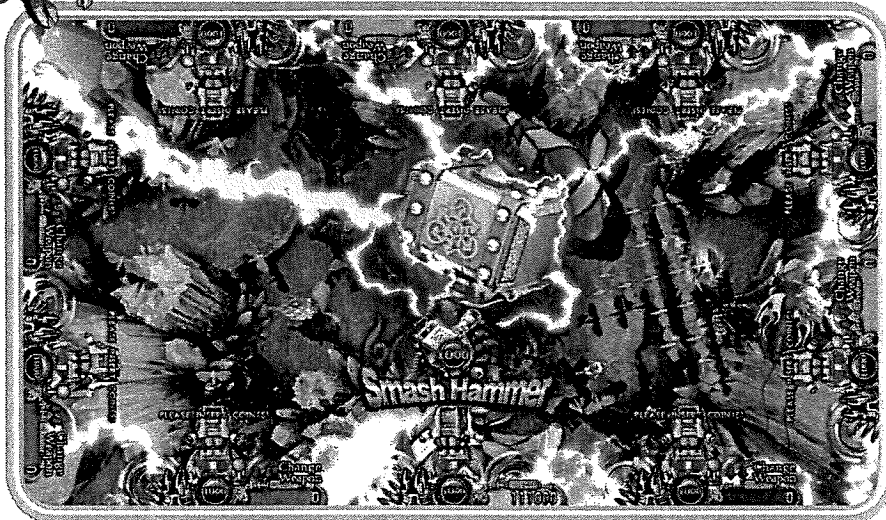

► Catching a Smash Hammer Crab will trigger the blazing hammer to smashes everything in the front and may have a chance to catch all fishes in the field.

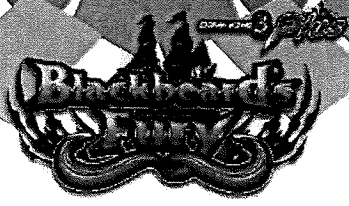

6.

Lightning Chain

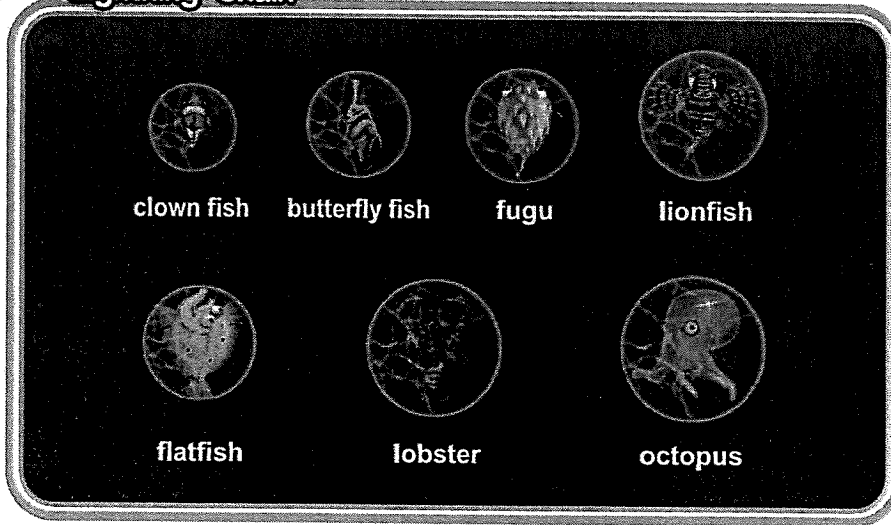

▶ Fish species in above will appeared as lightning fish.

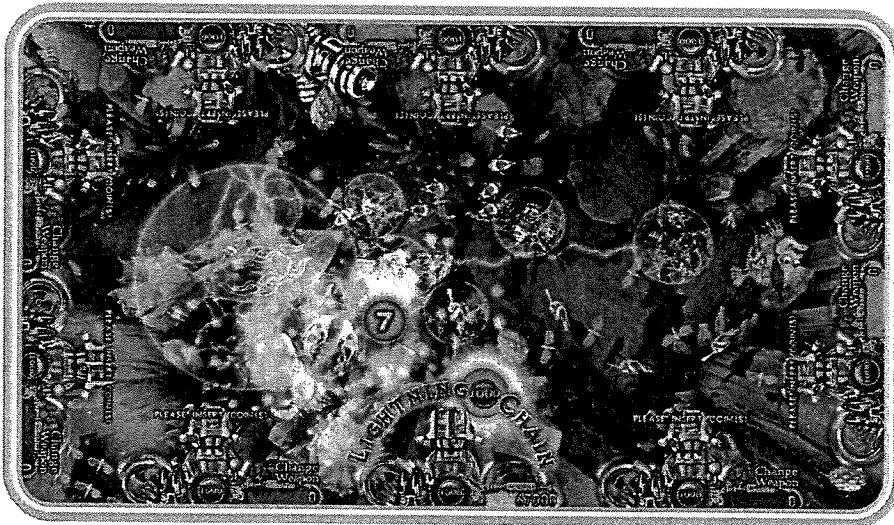

- ▶ Catching a Lightning Fish will trigger Lightning Chain.
- ▶ Lightning Chain will continue to catch fish automatically until it runs out.



7 **Vortex Fish**

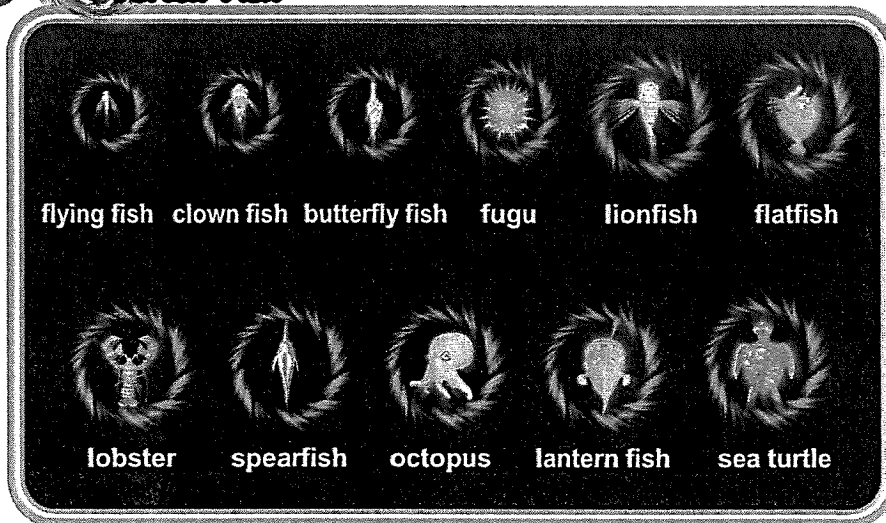

► Fish species in above will appeared as Vortex Fish.

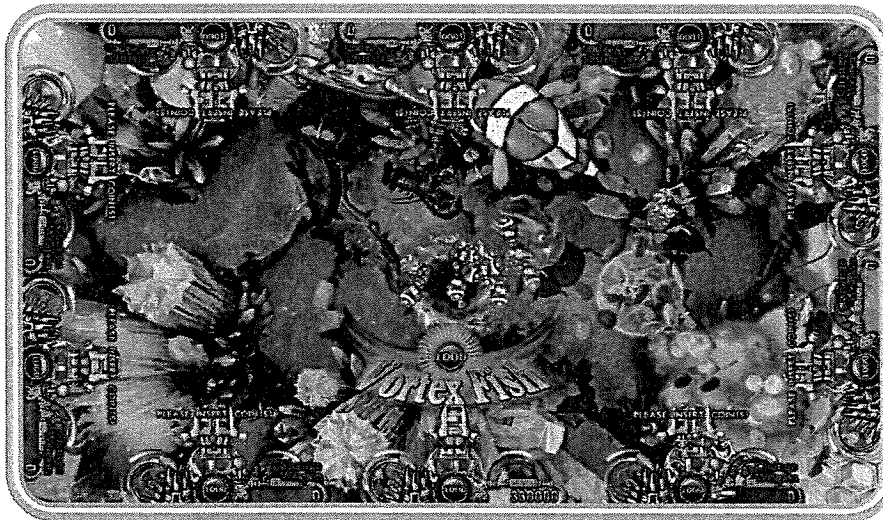

► Catching a Vortex Fish will suck all fish of the same species in the area into a whirlpool.



8. FIRE STORM

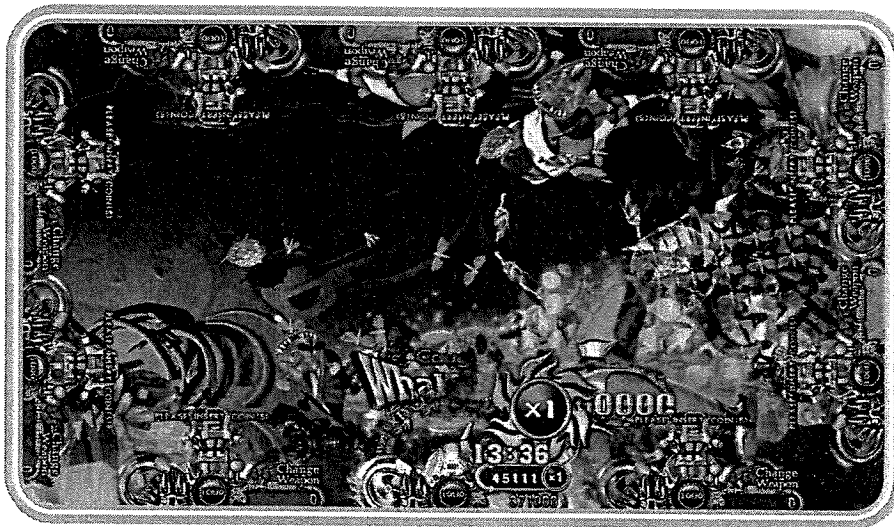
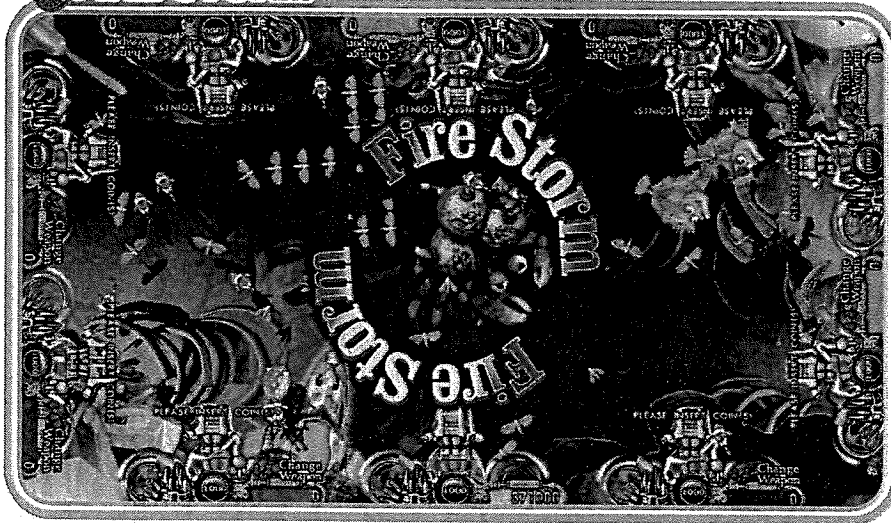

- ▶ It's a single-player game free for a limited time, randomly accessible through the main game.
- ▶ Players are able to catch fish within the limited time, and may obtain additional time and multiply their scores during the game.
- ▶ When pressing button in quick succession, you can increase the attack speed.
- ▶ The final scores will be multiplied by the multiplying value as the result.



9. GOLDEN TREASURES

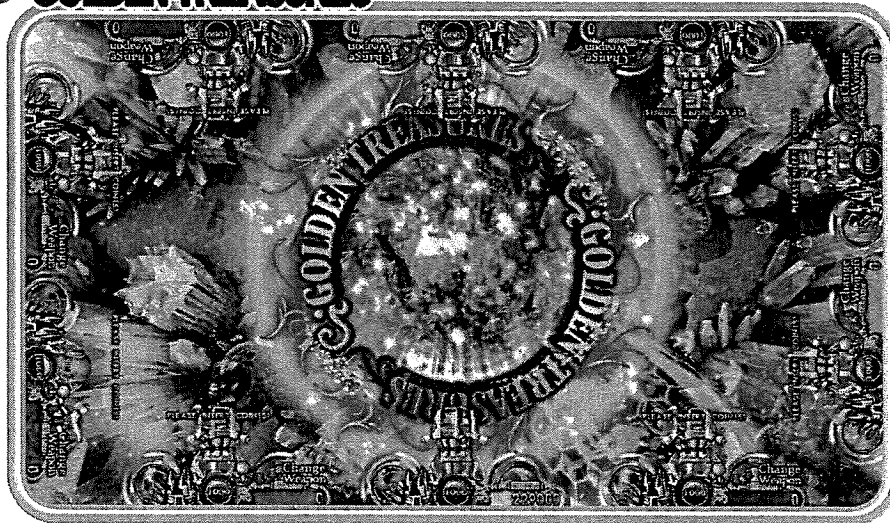

- ▶ It's a multi-player game free for a limited time, randomly accessible through the main game.
- ▶ Players use the searchlight and look for Imperial Whale and Golden Fish to get high scores.
- ▶ Players may obtain a roulette treasure box that adds in or multiplies the total scores.



10. Thunder Dragon

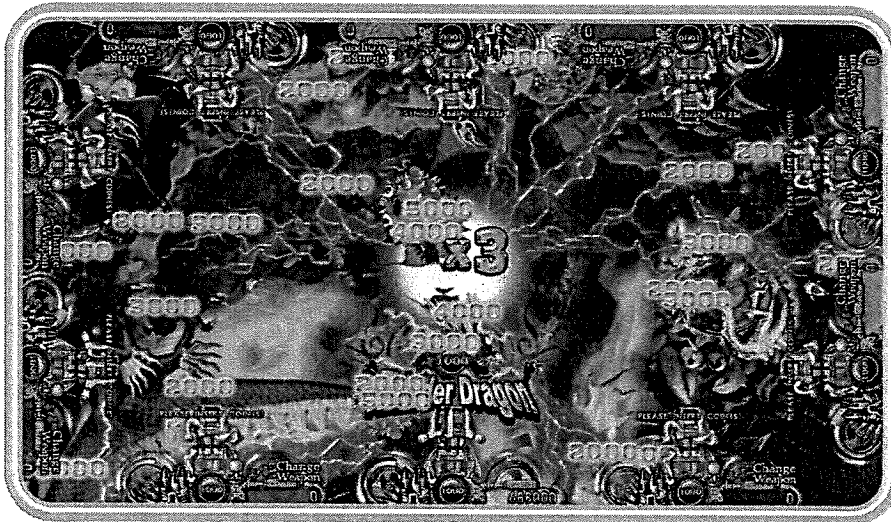

► Catching Thunder Dragon can summon large amount of dragons to attack all the fish in the sea, and any kinds of fish can be probably captured. And may have a chance to multiply the win.



2. Using the System Utility

• Menu Navigation

Pressing the [System] key on the control box allows you to access the System utility.

Notes!!!

To avoid problems caused by improper operations during the play, the following rules are enforced:

1. When any hopper or ticket dispenser is operating, no access to System Utility is allowed.
2. If there is any bullet in the fish farm, the System Utility will not be accessible.
3. During any special play (such as the Super Bomb), no access to System Utility is allowed.

• The menu navigation is as below:

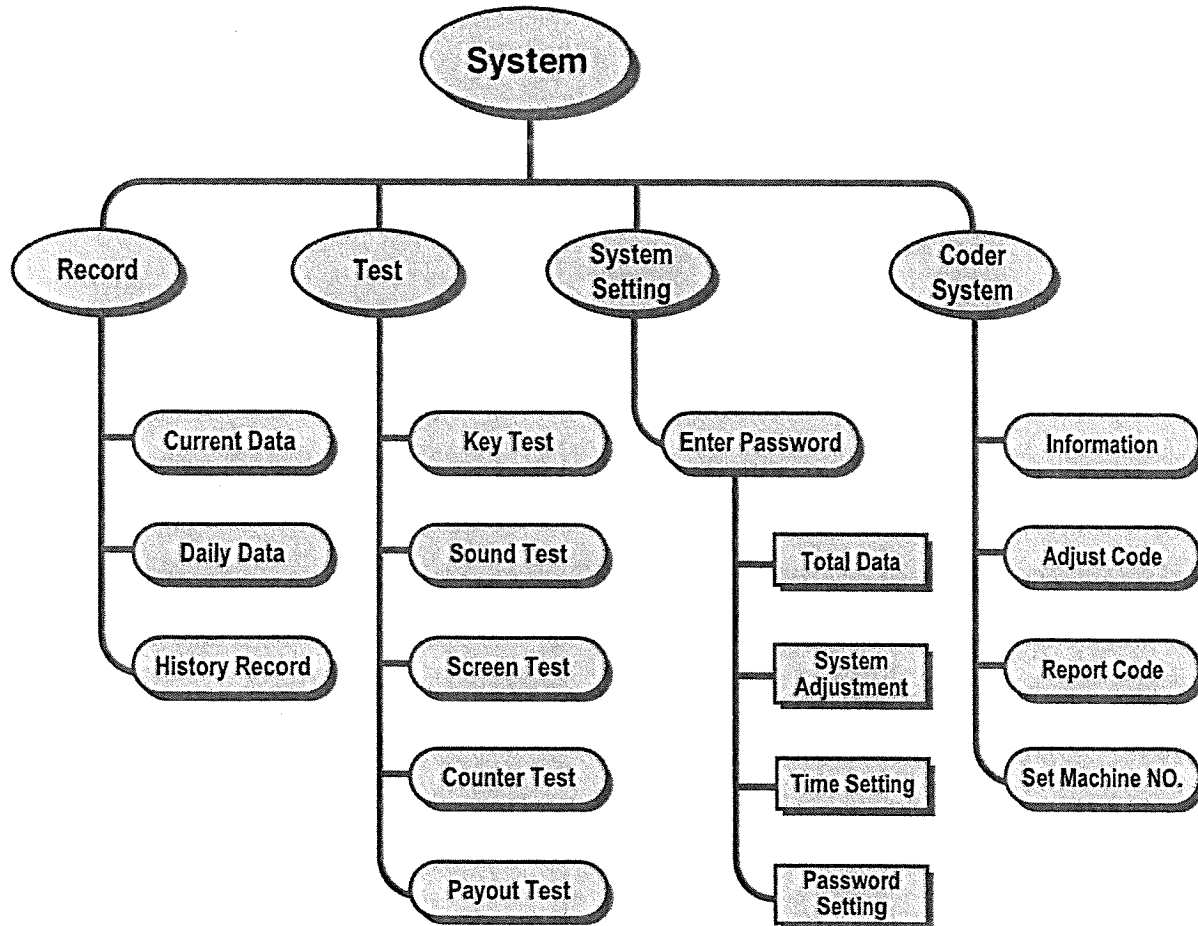

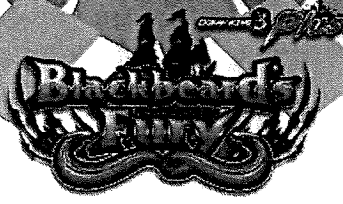

• Main Menu:

▶ To go to the page of System Utility, press the [System] button, and you will see [Main menu].

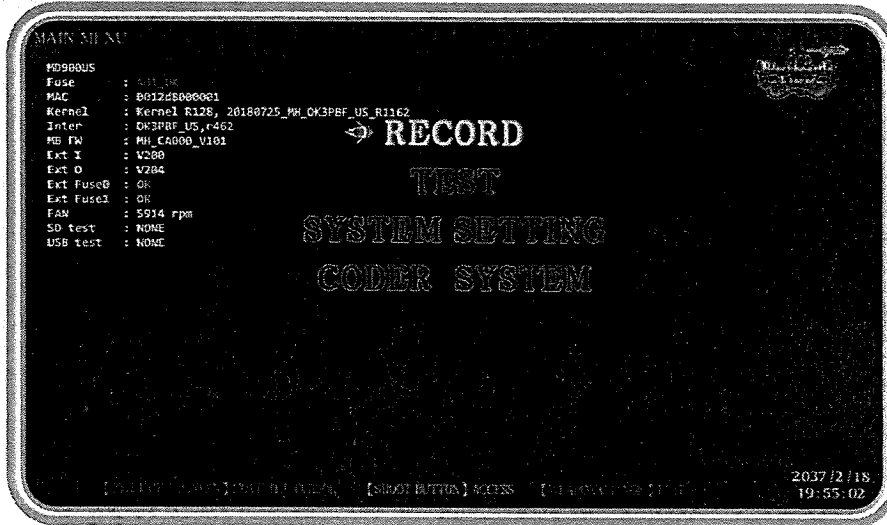

• Record

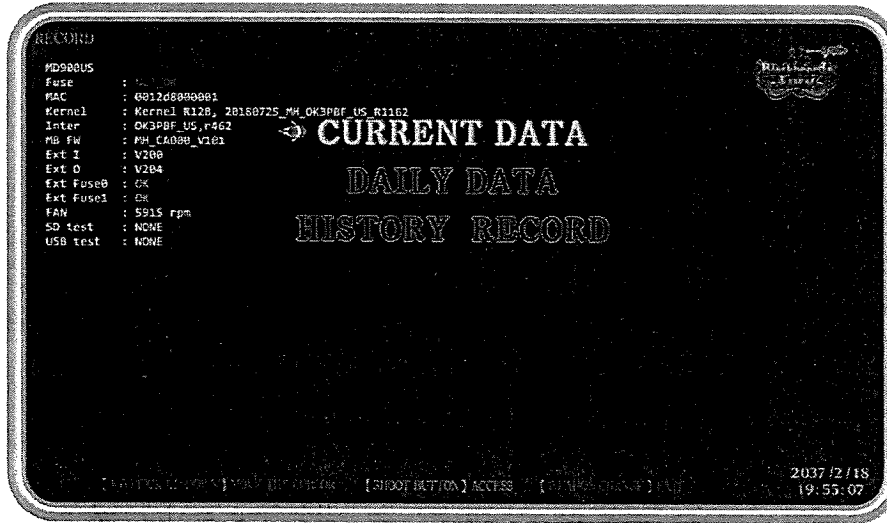

▶ **Current Data:** operators can check their current and previous total in, total out, coin in, and coin out, etc. operators can also update their shift records.

▶ **Daily Data:** Provides daily data such as the total in/out number and percentage (within the last 42 days).

▶ **History Record:** List of latest 100 games' winning scores.



• Test



▶ Test hardware devices of the machine to ensure its normal functions.

- ▶ **Key test:** Test if input and output devices of the machine function normally.
- ▶ **Sound test:** Test whether the sound output is normal.
- ▶ **Screen test:** Check whether the screen display is normal.
- ▶ **Counter test:** Check whether each counter is functioning normally.
- ▶ **Payout test:** Check whether each coin selector , hopper and ticket dispenser is functioning normally.



• System Setting

- ▶ Before players get access to the [system] page, insert password first.
The default password is twelve zeroes.

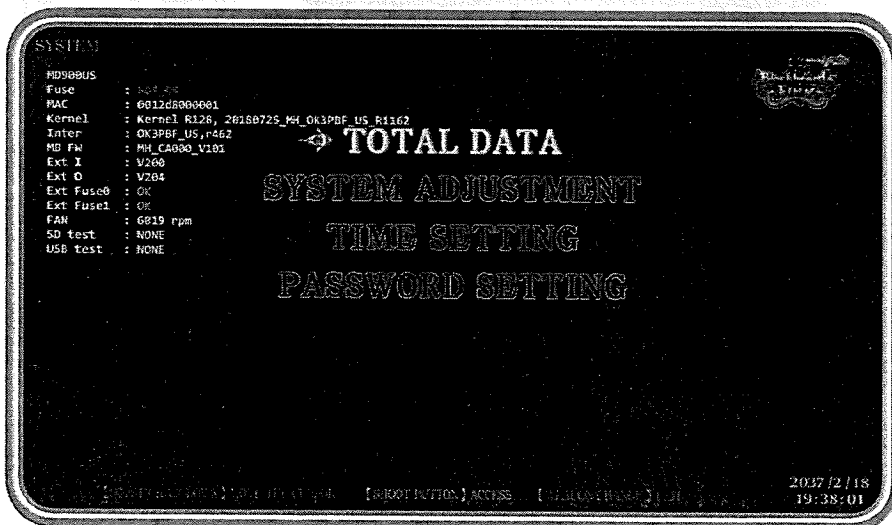
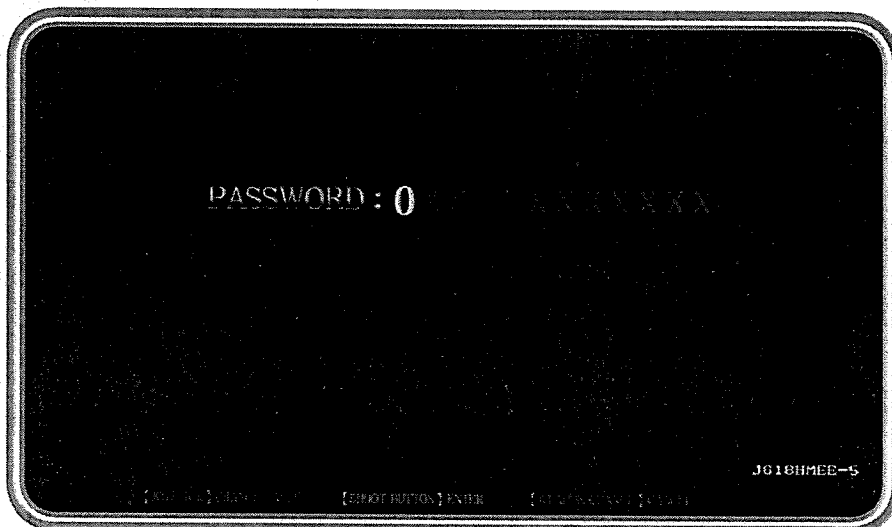

- ▶ **Total data:** To view a complete account and check their revenue.
- ▶ **System adjustment:** To set up parameter regarding the game.
- ▶ **Time setting:** To adjust the time.
- ▶ **Password setting:** Reset the password for the [system] page.



• System Adjustment

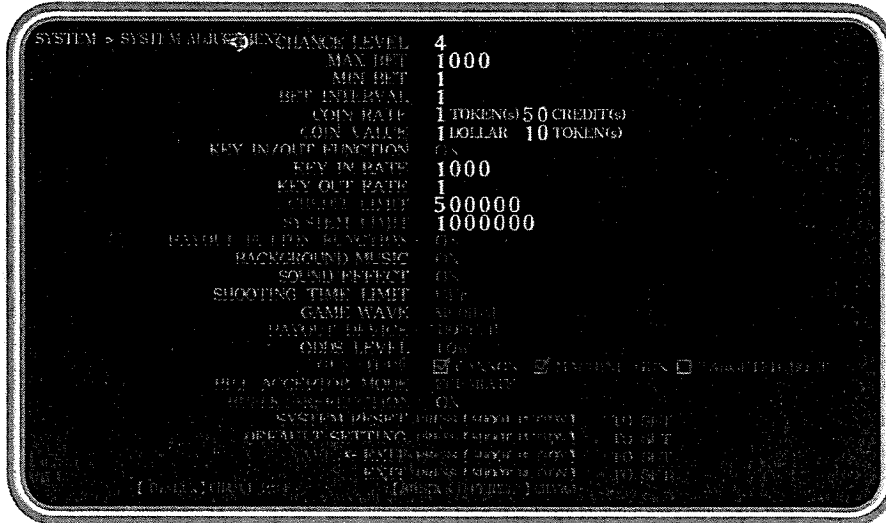

1. Move the joystick up and down to move the cursor, and left and right to switch options.
2. **Game Settings:**

Items	Adjustable Range	Default
CHANCE LEVEL	1~30	4
MAX BET	8 / 12 / 20 / 30 / 40 / 50 / 60 / 70 / 80 / 99 / 100 / 150 / 200 / 250 / 300 / 350 / 400 / 450 / 500 / 999 / 1000	1000
MIN BET	1~10 / 20 / 30 / 40 / 50 / 99 / 100 / 150 / 200 / 250 / 300 / 350 / 400 / 450 / 500 / 999 / 1000	1
BET INTERVAL	1~50	1
COIN RATE	1TOKEN(S) 1 / 2 / 3 / 4 / 5 / 6 / 7 / 8 / 9 / 10 / 20 / 25 / 30 / 40 / 50 / 100 / 150 / 200 / 250 / 300 / 350 / 400 / 450 / 500 / 550 / 600 / 650 / 700 / 750 / 800 / 850 / 900 / 950 / 1000 CREDIT(S) <div style="border: 1px solid black; padding: 5px; margin-top: 5px;">This item is shown when the Time Remain of the coder is set at Forever.</div>	1 TOKEN 50 CREDIT(S)
COIN VALUE	1 DOLLAR 1~50 TOKEN(S)	1 DOLLAR 10 TOKEN(S)
KEY IN/OUT FUNCTION	OFF · KEY OUT ONLY · ON	ON
KEY IN RATE	10 · 20 · 30 · 40 · 50 · 100 · 150 · 200 · 250 · 300 · 350 · 400 · 450 · 500 · 1000 · 2000 · 3000 · 4000 · 5000 · 10000	1000
KEY OUT RATE	1 · 10 · 20 · 30 · 40 · 50 · 100 · 150 · 200 · 250 · 300 · 350 · 400 · 450 · 500 · 1000 · 2000 · 3000 · 4000 · 5000 · 10000	1
CREDIT LIMIT	100000 · 150000 · ... · 500000 · 600000 · 700000 · ... · 1000000	500000
SYSTEM LIMIT	200000 · 300000 · ... · 2000000	1000000
PAYOUT BUTTON FUNCTION	ON · OFF	ON

** Note:
New board w/
slightly different
platform.
Communication cable
has serial conn to board
Chance level addition
Level: 30, 35, 40, 45, 50
(also Master of the
Deep "unicorn")*

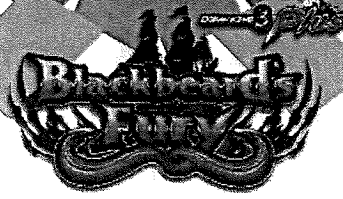

Items	Adjustable Range	Default
BACKGROUND MUSIC	ON \ OFF	ON
SOUND EFFECT	ON \ OFF	ON
SHOOTING TIME LIMIT	ON \ OFF	OFF
GAME WAVE	LOW \ MEDIUM \ HIGH	MEDIUM
PAYOUT DEVICE	HOPPER \ PRINTER	HOPPER
ODDS LEVEL	LOW \ HIGH	LOW
GUN TUBE	CANNON+MACHINE GUN \ MACHINE GUN+TARGETED BOLT \ CANNON+MACHINE GUN+TARGETED BOLT	CANNON+MACHINE GUN
BILL ACCEPTOR MODE	SEPARATE \ SHARED <div style="border: 1px solid black; padding: 5px; margin-top: 5px;"> <p>· When changing Bill Acceptor Mode, make sure that the bill acceptor wiring scheme of Bill Acceptor is adjusted as well. Please refer to the instructions of Bill Acceptor Wiring Scheme as shown below.</p> </div>	SEPARATE
BULLET REFLECTION	ON \ OFF	ON

- ▶ **SYSTEM RESET:** Erase all revenue and game data.
- ▶ **DEFAULT SETTING:** Reset all items to the default setting.
- ▶ **SAVE & EXIT:** to save the changes and exit. Then you will go back to the [system] page.
- ▶ **EXIT:** to exit the [system] page without saving the changes.

Notes!!!

1. Change Coin Rate: Players' credit will be reset to zero.
2. Change OPERATION MODE: This step will set players' Credit, number of coins to zero.
3. Credit Limit: The player can continue to play after the Credit Limit is reached, although any new tokens inserted will be returned and credits cannot be keyed in.
4. System Limit: When credit reaches system limit score, the Syetem Limit message will appear. Any new tokens inserted will be returned. Players may continue to play, key out, or payout to cancel the system limit status.



• Coder System

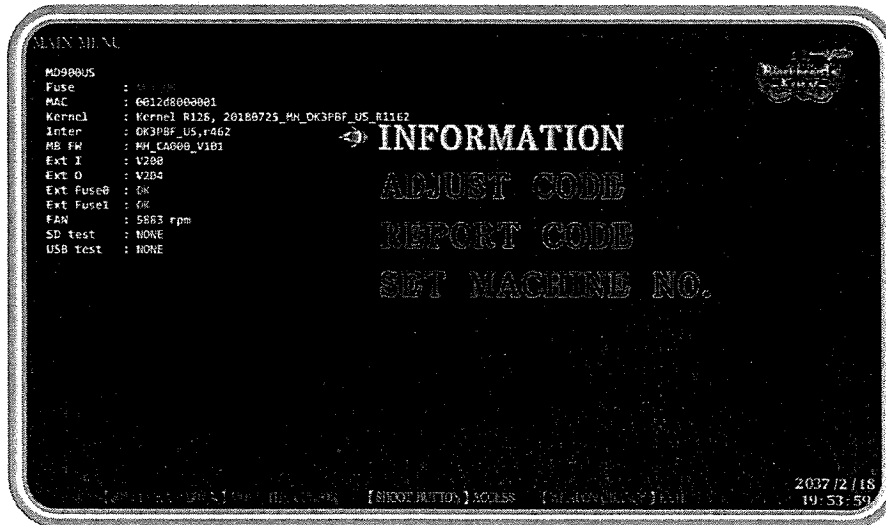

- ▶ **Information:** All information of the coder system.
- ▶ **Adjust Code:** Setting "Coin Rate" or "Time Limit".
- ▶ **Report Code:** Report or clear the records of the coder system.
- ▶ **Set Machine NO.:** Setting machine number.

Notes!!!

If the value of "Time Remain" is "Forever",

1. Enter report code 00000000000 can clear records directly.
2. Enter below adjust codes can set the coin rate directly:

00000000000	1:1	00000000017	1:200
00000000001	1:2	00000000018	1:250
00000000002	1:3	00000000019	1:300
00000000003	1:4	00000000020	1:350
00000000004	1:5	00000000021	1:400
00000000005	1:6	00000000022	1:450
00000000006	1:7	00000000023	1:500
00000000007	1:8	00000000024	1:550
00000000008	1:9	00000000025	1:600
00000000009	1:10	00000000026	1:650
00000000010	1:20	00000000027	1:700
00000000011	1:25	00000000028	1:750
00000000012	1:30	00000000029	1:800
00000000013	1:40	00000000030	1:850
00000000014	1:50	00000000031	1:900
00000000015	1:100	00000000032	1:950
00000000016	1:150	00000000033	1:1000



3. Manual of Coder

• Power On

You can see the version, Agent No. and Store No. when you power on the coder.

• Functions

▶ Adjust code:

Input two data got from the game machine : 1. Machine No., 2. Check ID, then select a option you want to adjust:

(1) Coin Rate

1.	1:1	10.	1:10	19.	1:250	28.	1:700
2.	1:2	11.	1:20	20.	1:300	29.	1:750
3.	1:3	12.	1:25	21.	1:350	30.	1:800
4.	1:4	13.	1:30	22.	1:400	31.	1:850
5.	1:5	14.	1:40	23.	1:450	32.	1:900
6.	1:6	15.	1:50	24.	1:500	33.	1:950
7.	1:7	16.	1:100	25.	1:550	34.	1:1000
8.	1:8	17.	1:150	26.	1:600		
9.	1:9	18.	1:200	27.	1:650		

(2) Time Limit

1.	80 hours	5.	250 hours	9.	450 hours	13.	650 hours
2.	100 hours	6.	300 hours	10.	500 hours	14.	700 hours
3.	150 hours	7.	350 hours	11.	550 hours	15.	750 hours
4.	200 hours	8.	400 hours	12.	600 hours	16.	forever

You will get a 12-digit adjust code finally. Input the code on the game machine to change the setting.



▶ Report Code

Input five data got from the game machine : 1. Total Income, 2. Income, 3. Machine No., 4. Report Times, 5. Check ID.

You will get a 12-digit report code finally. Input the code on the game machine to reset the "Time Remain" value to be "Time Limit" setting.

▶ HW Test

Test all hardware functions.

• Troubleshooting

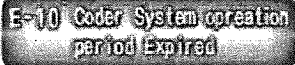
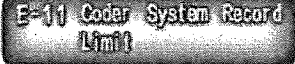
Tip icon	Meaning
	Input report code in the coder system to reset time limit.
	Input report code in the coder system to clear records.



4. Installing instruction for IO board

• Instructions of Control Panel Connector

Power Supply: 12V 8.5A

Providing power supply for IO board

Power Supply: 24V

Providing power supply for motor control panel

Control Panel Connector
(CON13~22)

Power Supply Connector
(CON24)

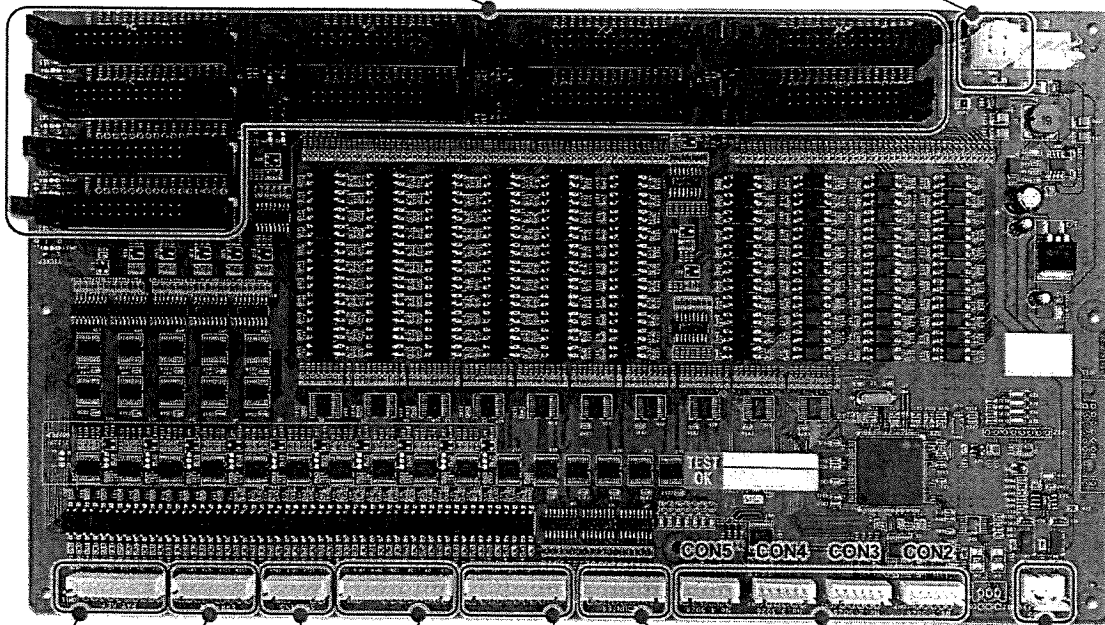

Bill Acceptor Connector
(CON10)

Bill Acceptor Connector
(CON8)

Counter Connector
(CON6)

Communication Connector

Coin Out Connector
(CON11)

System button Connector
(CON9)

Joystick Lamp Connector
(CON7)

Lamp Panel Connector
(CON2~5)



• **Control Panel Connector (CON13~22):**

▶ The number order on the circuit board connector

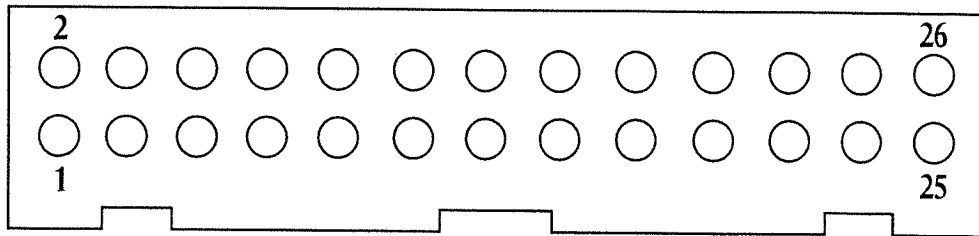

▶ connector

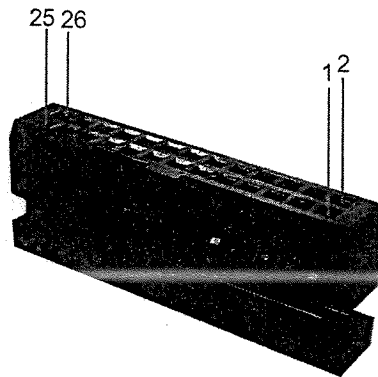

▶ 1P(CON13)

2	4	6	8	10	12	14	16	18	20	22	24	26
Direction_down	Direction_left	Shoot button	Key in	Controlling Hopper turn counterclockwise	Hopper feedback	Controlling Hopper turn clockwise	Lamp of the Change weapon button	+12V	+12V	GND	GND	GND
				○	○	○	○					
Direction_up	Direction_right	Power button	Messages for inserting coins	Key out	Printer Error feedback	Printer Payout Trigger Control	Lamp of the shooting button	+12V	+12V	+5V	GND	GND
					○	○	○					
1	3	5	7	9	11	13	15	17	19	21	23	25

▶ 2P(CON14)

2	4	6	8	10	12	14	16	18	20	22	24	26
Direction_down	Direction_left	Shoot button	Key in	Controlling Hopper turn counterclockwise	Hopper feedback	Controlling Hopper turn clockwise	Lamp of the Change weapon button	+12V	+12V	GND	GND	GND
				○	○	○	○					
Direction_up	Direction_right	Power button	Messages for inserting coins	Key out	Printer Error feedback	Printer Payout Trigger Control	Lamp of the shooting button	+12V	+12V	+5V	GND	GND
					○	○	○					
1	3	5	7	9	11	13	15	17	19	21	23	25



▶3P(CON15)

2	4	6	8	10	12	14	16	18	20	22	24	26
Direction_down 	Direction_left 	Shoot button 	Key in 	Controlling Hopper turn counterclockwise O	Hopper feedback O	Controlling Hopper turn clockwise O	Lamp of the Change weapon button O	+12V	+12V	GND	GND	GND
1	3	5	7	9	11	13	15	17	19	21	23	25
Direction_up 	Direction_right 	Power button 	Messages for inserting coins 	Key out 	Printer Error feedback O	Printer Payout Trigger Control O	Lamp of the shooting button O	+12V	+12V	+5V	GND	GND

▶4P(CON16)

2	4	6	8	10	12	14	16	18	20	22	24	26
Direction_down 	Direction_left 	Shoot button 	Key in 	Controlling Hopper turn counterclockwise O	Hopper feedback O	Controlling Hopper turn clockwise O	Lamp of the Change weapon button O	+12V	+12V	GND	GND	GND
1	3	5	7	9	11	13	15	17	19	21	23	25
Direction_up 	Direction_right 	Power button 	Messages for inserting coins 	Key out 	Printer Error feedback O	Printer Payout Trigger Control O	Lamp of the shooting button O	+12V	+12V	+5V	GND	GND

▶5P(CON17)

2	4	6	8	10	12	14	16	18	20	22	24	26
Direction_down 	Direction_left 	Shoot button 	Key in 	Controlling Hopper turn counterclockwise O	Hopper feedback O	Controlling Hopper turn clockwise O	Lamp of the Change weapon button O	+12V	+12V	GND	GND	GND
1	3	5	7	9	11	13	15	17	19	21	23	25
Direction_up 	Direction_right 	Power button 	Messages for inserting coins 	Key out 	Printer Error feedback O	Printer Payout Trigger Control O	Lamp of the shooting button O	+12V	+12V	+5V	GND	GND

▶6P(CON18)

2	4	6	8	10	12	14	16	18	20	22	24	26
Direction_down 	Direction_left 	Shoot button 	Key in 	Controlling Hopper turn counterclockwise O	Hopper feedback O	Controlling Hopper turn clockwise O	Lamp of the Change weapon button O	+12V	+12V	GND	GND	GND
1	3	5	7	9	11	13	15	17	19	21	23	25
Direction_up 	Direction_right 	Power button 	Messages for inserting coins 	Key out 	Printer Error feedback O	Printer Payout Trigger Control O	Lamp of the shooting button O	+12V	+12V	+5V	GND	GND



▶7P(CON19)

2	4	6	8	10	12	14	16	18	20	22	24	26
Direction_down 	Direction_left 	Shoot button 	Key in 	Controlling Hopper turn counterclockwise ○	Hopper feedback ○	Controlling Hopper turn clockwise ○	Lamp of the Change weapon button ○	+12V	+12V	GND	GND	GND
Direction_up 	Direction_right 	Power button 	Messages for inserting coins 	Key out 	Printer Error feedback ○	Printer Payout Trigger Control ○	Lamp of the shooting button ○	+12V	+12V	+5V	GND	GND
1	3	5	7	9	11	13	15	17	19	21	23	25

▶8P(CON20)

2	4	6	8	10	12	14	16	18	20	22	24	26
Direction_down 	Direction_left 	Shoot button 	Key in 	Controlling Hopper turn counterclockwise ○	Hopper feedback ○	Controlling Hopper turn clockwise ○	Lamp of the Change weapon button ○	+12V	+12V	GND	GND	GND
Direction_up 	Direction_right 	Power button 	Messages for inserting coins 	Key out 	Printer Error feedback ○	Printer Payout Trigger Control ○	Lamp of the shooting button ○	+12V	+12V	+5V	GND	GND
1	3	5	7	9	11	13	15	17	19	21	23	25

▶9P(CON21)

2	4	6	8	10	12	14	16	18	20	22	24	26
Direction_down 	Direction_left 	Shoot button 	Key in 	Controlling Hopper turn counterclockwise ○	Hopper feedback ○	Controlling Hopper turn clockwise ○	Lamp of the Change weapon button ○	+12V	+12V	GND	GND	GND
Direction_up 	Direction_right 	Power button 	Messages for inserting coins 	Key out 	Printer Error feedback ○	Printer Payout Trigger Control ○	Lamp of the shooting button ○	+12V	+12V	+5V	GND	GND
1	3	5	7	9	11	13	15	17	19	21	23	25

▶10P(CON22)

2	4	6	8	10	12	14	16	18	20	22	24	26
Direction_down 	Direction_left 	Shoot button 	Key in 	Controlling Hopper turn counterclockwise ○	Hopper feedback ○	Controlling Hopper turn clockwise ○	Lamp of the Change weapon button ○	+12V	+12V	GND	GND	GND
Direction_up 	Direction_right 	Power button 	Messages for inserting coins 	Key out 	Printer Error feedback ○	Printer Payout Trigger Control ○	Lamp of the shooting button ○	+12V	+12V	+5V	GND	GND
1	3	5	7	9	11	13	15	17	19	21	23	25



• **Power Supply Connector (CON24):**

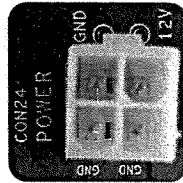

GND	+12V
GND	GND

• **Counter Connector (CON6):**

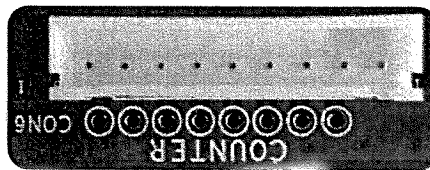

9	8	7	6	5	4	3	2	1
0	0	0	0	0	0	0	0	+12V
TEST4	TEST3	TEST2	TEST1	Counter D	Counter C	Counter B	Counter A	

• **Bill Acceptor Connector (CON10&CON8):**

▶ IO Board CON10 Connector

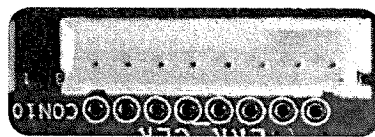

8	7	6	5	4	3	2	1
I_8P_	I_7P_	I_6P_	I_5P_	I_4P_	I_3P_	I_2P_	I_1P_
Bill Acceptor	Bill Acceptor	Bill Acceptor	Bill Acceptor	Bill Acceptor	Bill Acceptor	Bill Acceptor	Bill Acceptor

▶ IO Board CON8 Connector

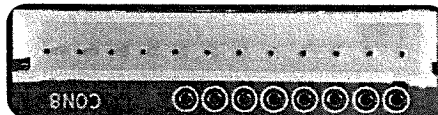

12	11	10	9	8	7	6	5	4	3	2	1
				B_IN7	B_IN6	B_IN5	B_IN4	B_IN3	B_IN2	I_10P_	I_9P_
										Bill Acceptor	Bill Acceptor

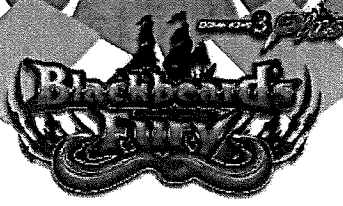

• Joystick Lamp Connector (CON7) :

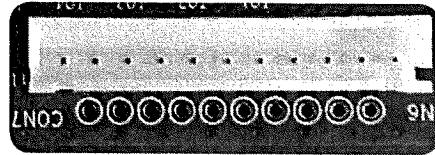

11	10	9	8	7	6	5	4	3	2	1
0	Joystick lamp 10P	Joystick lamp 9P	Joystick lamp 8P	Joystick lamp 7P	Joystick lamp 6P	Joystick lamp 5P	Joystick lamp 4P	Joystick lamp 3P	Joystick lamp 2P	Joystick lamp 1P

• System Button Connector (CON9):

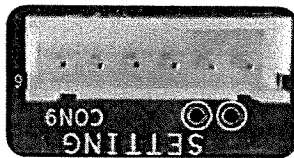

6	5	4	3	2	1
GND					System button

• Communication Connector (CON12):

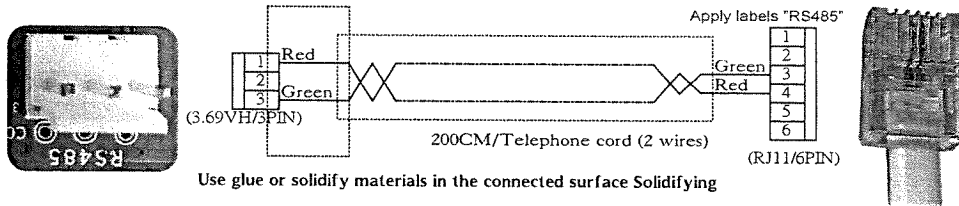

• Coin Out Connector (CON11):



10	9	8	7	6	5	4	3	2	1
Coin out 10P	Coin out 9P	Coin out 8P	Coin out 7P	Coin out 6P	Coin out 5P	Coin out 4P	Coin out 3P	Coin out 2P	Coin out 1P



• **Bill Acceptor Wiring Scheme: (Model: PA7/PV7)**

If the Bill Acceptor is substituted for another one, please take notice with connection.

▶ IO Board CON10 Connector

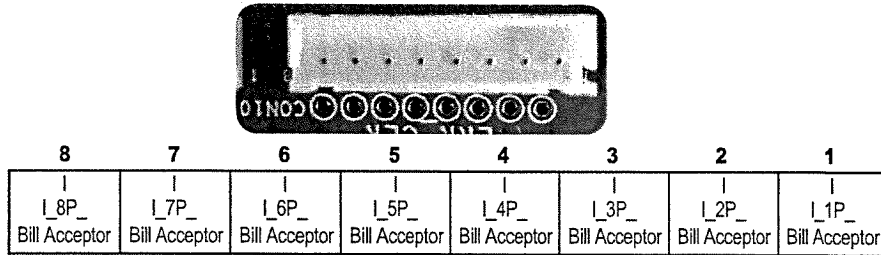

▶ IO Board CON8 Connector

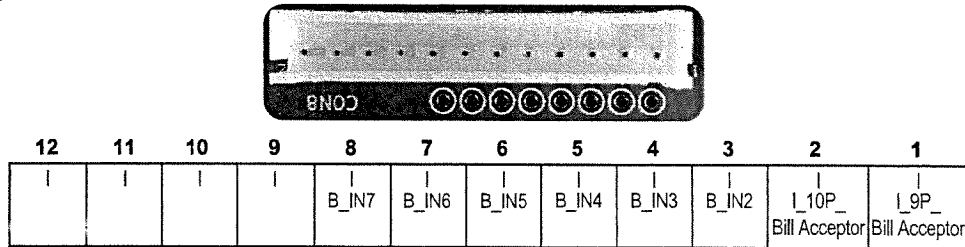

▶ Bill Acceptor Connector

PIN 1- YELLOW.....	INHIBIT+
PIN 2- GREEN.....	INHIBIT-
PIN 3- Reserved	
PIN 4- Reserved	
PIN 5- RED.....	12V DC (Power)
PIN 5 Dotted- BLACK.....	12V DC (Power)
PIN 6- Reserved	
PIN 7- BLUE.....	CREDIT_RELAY (N.O.)
PIN 8- PURPLE.....	CREDIT_RELAY (Common)
PIN 9- BROWN.....	GND (Power)
PIN 9 Dotted- WHITE.....	GND (Power)

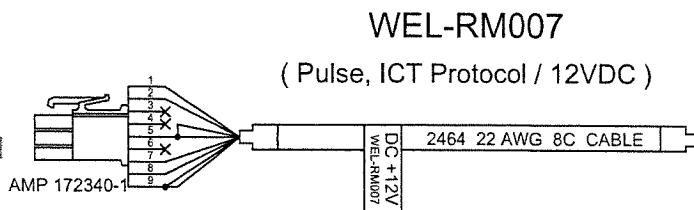

▶ Bill Acceptor Wiring

Bill Acceptor Connector

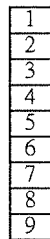

Blue/22AWG

IO Board
CON10 Connector

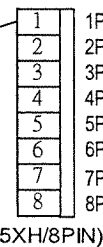

IO Board
CON8 Connector

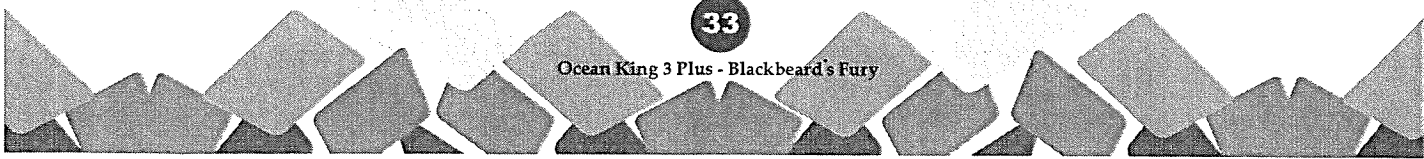
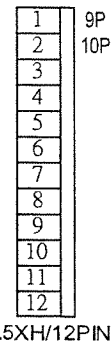



• Bridge board of the hopper:

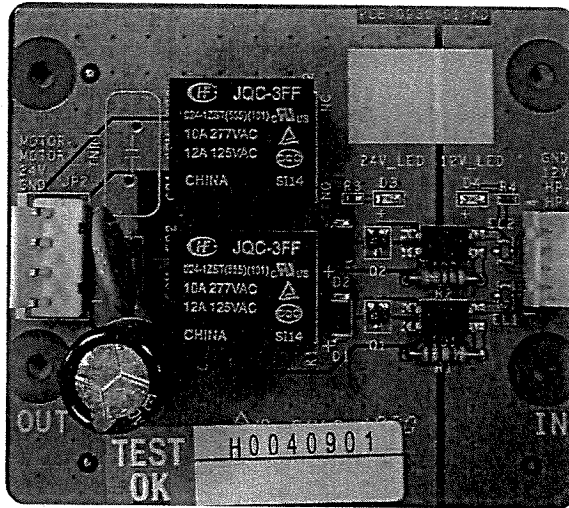

4	3	2	1
GND	+12V	Controlling motor_ turn counterclockwise	Controlling motor_ turn clockwise

JP1

4	3	2	1
Motor negative electrode	Motor positive electrode	+24V	GND

JP2



• Instructions of M01 Connector:

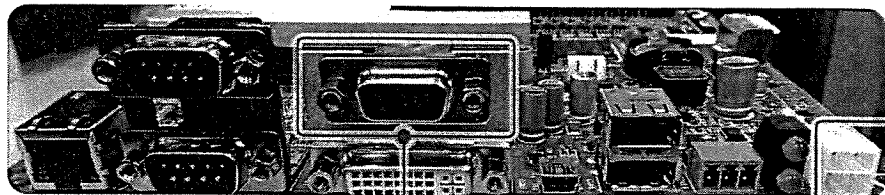
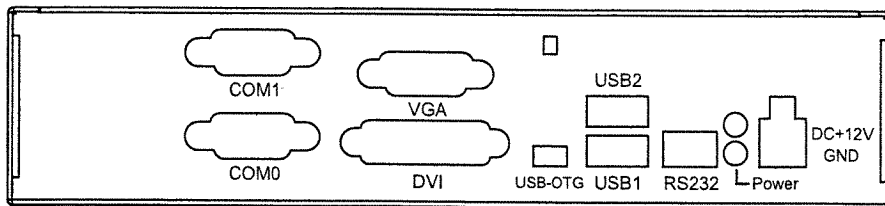

Power supply connector
DC12V

12V	12V
GND	GND

VGA Connector

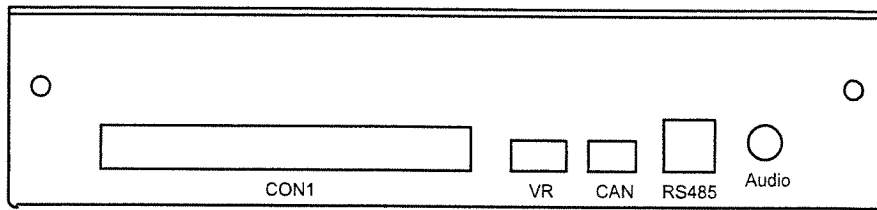

RS485 Connector Audio Connector

• Game mode switch :

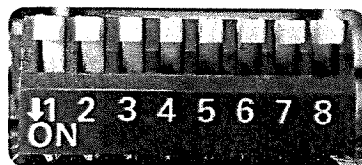

DIPSW

DIP Switch Setting								
Mode	1	2	3	4	5	6	7	8
6 Player (2-1-2-1)	-	-	-	-	-	OFF	OFF	OFF
8 Player (3-1-3-1)	-	-	-	-	-	OFF	OFF	ON
4 Player (2-2)	-	-	-	-	-	OFF	ON	OFF
4 Player (4)	-	-	-	-	-	OFF	ON	ON
10 Player (3-2-3-2)	-	-	-	-	-	ON	OFF	OFF
8 Player (4-4)	-	-	-	-	-	ON	OFF	ON
10 Player (4-1-4-1)	-	-	-	-	-	ON	ON	OFF
4 Player (1-1-1-1)	-	-	-	-	-	ON	ON	ON

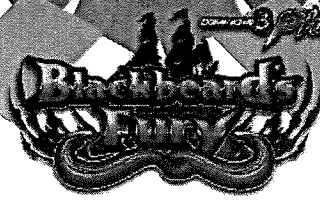

5 Troubleshooting

Tip icon	Meaning
E-01 Jammed Coin selector	Check if any coin is stuck in the coin slot machine, and after this problem is solved, press the [key in] to clear error status.
E-02 Hopper Jam	Check if any coin is stuck in the hopper, especially in the opening spot. After this problem is solved, press the [Key in] to clear error status and continue having hopper out.
E-03 Hopper Empty	After the required number of coins is inserted, press the [Key in] to clear error status and continue having coins out.
E-04 Ticket Jam	Check if any ticket is stuck in the ticket dispenser or printer, and after this problem is solved, press the [Key in] to clear error status and continue having tickets out.
E-05 Ticket Empty	After the required number of tickets is added in, press the [Key in] to clear error status and continue having tickets out.
E-06 Credit Error	An error occurred in the Credit, which means something is wrong in the memory of the main board, and the cabinet has to be restarted. The system will also automatically run the resetting.
E-07 Record Limit	The records of players' account had reached their upper limits; press the [system] button to enter system's menu and run the resetting.
E-08 Control Panel Error	Check if something goes wrong in the connection of the main cabinet and the control panel.
E-09 Bill Acceptor Error	Check if any bill is stuck in the acceptor and after this problem is solved, press the [Key in] to clear error status.
System Limit	When Credit reaches system limit score, the System Limit message will appear. Any new tokens inserted will be returned.

★ After the [key in] is pressed to do troubleshooting, the key in function will be returned after 5 seconds.



6. Note

1. The upper limit of credit:
 - A. When players' credit reaches limit, the extra coins inserted will come out.
 - B. When players' earning credit reaches limit, the extra coins inserted will come out.
2. After the cabinet is restarted, the system will erase previously running games, and continue with the main game.